

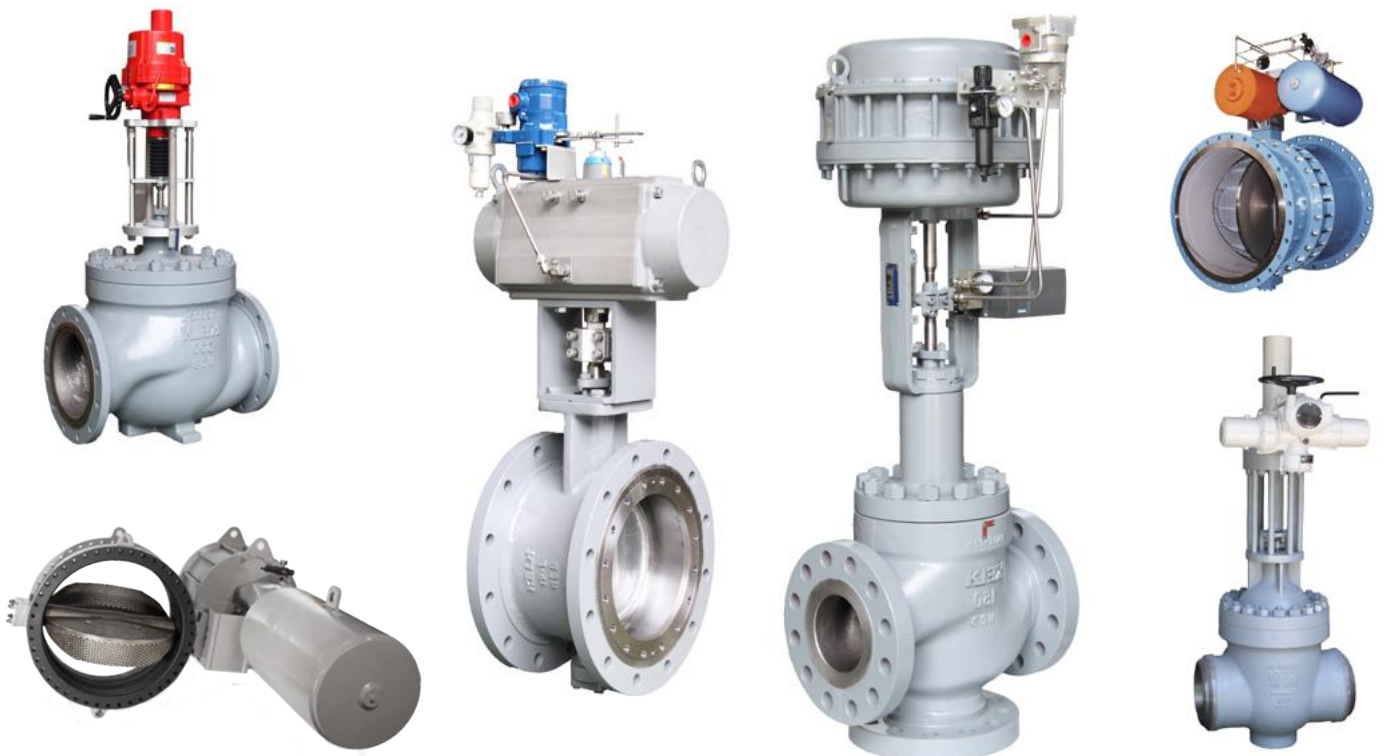

# 特色产品手册

# OVERVIEW BROCHURE



Since 1965

**KELK**  
Flow Control

# 60 年的阀门制造经验 因为专一所以专业 OVER 60 YEARS IN THE INDUSTRY

**KELK** 无锡公司是一家中国与加拿大合资的专业控制阀制造商。通过从加拿大 KELK 引进先进的设计技术，优秀的管理经验及质量管理体系，依托原无锡仪表阀门有限公司的控制阀铸造、加工及装配能力，成立了无锡 KELK 仪表阀门有限公司。

无锡 KELK 致力于流体控制的解决方案，开发出了适用于广泛领域的各种流体控制设备，尤其在控制阀领域给予了各行业的过程自动化很大贡献。

Wuxi KELK Apparatus & Valve Co., Ltd is a Canadian-Chinese joint venture specialized in manufacturing control valves. It was established based on original Wuxi Apparatus & Valve Co., Ltd. We introduced the advanced technology, excellent management experience and a sound quality management system from Canada.

Wuxi KELK is committed to providing flow control solutions, and has developed a wide range of flow control equipment, especially in the field of control valve.

仪器仪表  
INSTRUMENTS AND APPARATUSES

控制阀门和控制系统  
VALVES AND CONTROLS

执行器  
ACTUATOR

压力控制设备  
PRESSURE CONTROL EQUIPMENT

辅助设备  
AUXILIARY EQUIPMENT



# 在各个工业控制领域服务超过 60 年

## Serving the industries for over 60 years



凯尔克公司为石油天然气、石化、冶金、电力能源等工业控制领域和仪器仪表行业供应设备和维护设备超过 60 年，特别是控制阀和具有高技术含量的控制设备以及客户支持服务。

KELK company have supplied and maintained equipment for the power and industrial industries for over 60 years, specializing in rotating equipment and controls delivered with superior technical and customer support.

### 质量保证

#### Quality assurance

采用如下技术标准，保证品质。  
Using the following technical standards

标准和体系认证：

Standards and system certification

- TSGA1A2B:2021
- TSGD7002-2006
- ISO9001:2015
- ISO45001:2018
- ISO14001:2015
- ISO10012:2003
- IEC61508:2010 PARTS1-7
- PED 97/23/CE
- API607 2016
- API6FA 2020
- ISO15848-1:2015+A1:2017

标准和性能测试：

Standards and performance certification

- GB/T 4213
- JB/T 7387
- API 598
- ASME B16.34
- IEC60534



### KELK 阀门主要产品范围

#### Main product ranges

GV/GC 调节阀系列 GV/GC Control Valve Series:

- 直通调节阀系列 Straight Through Control Valve Series
- 角型调节阀系列 Rotary Control Valve Series
- 夹套阀系列 Jacketed Valve Series
- 波纹管阀系列 Bellows Valve Series

BE/BC 调节球阀系列 BE/BC Ball Control Valve Series

- 偏心调节球阀 Eccentric Ball Control Valve
- V 型调节球阀 V-port Ball Control Valve

GT 闸阀系列 Gate Valve Series

- 平行闸阀系列 Parallel Gate Valve Series

GZ 自力式阀系列 Self-operated Control Valve Series

BV 开关球阀系列 ON-OFF Ball Valve Series

- 软 / 硬密封球阀 Soft/Metal Seated Ball Valve
- 夹套球阀 Jacketed Ball Valve

BT 开关蝶阀系列 ON-OFF Butterfly Valve Series

- 风门挡板阀 Light Duty Damper Type Butterfly Valve
- 两偏心蝶阀 Double Offset Butterfly Valve
- 三偏心蝶阀 Triple Offset Butterfly Valve

- 三杆阀 Three Lever Valve

- 夹套蝶阀 Jacketed Butterfly Valve

## 安全性和环境保护至高无上

### Safety and environmental protection paramount

我们的目标是为客户提供优质的技术和优势的服务，以免对环境造成破坏。我们按照以下的要求进行工作：

- 避免伤害任何人员和设备
- 寻求能不断改善人身健康和安全性性能的方式
- 遵守所有的法律法规
- 所有具体操作符合 ISO 14001 和 ISO 45001 环境和职业安全管理标准

Our objective is to provide services that are technically and operationally superior and which provide business advantage to our customers. We conduct the business so as to avoid damage to the environment. It is our policy to conduct all our activities in such a way as to:

- Avoid harm to all personnel and assets which may be affected by our business.
- Seek progressive improvement of our health and safety performance.
- Comply with all applicable legislative requirements and other regulations.
- Specifically operate in compliance with standard ISO 14001 and ISO 45001 for environmental and safety management.



光谱分析  
Spectral analysis



膜厚试验  
Film thickness test

## 阀门测试

### Valve testing

所有的压载物品进行水压试验，阀座泄漏测试和功能测试。我们还可以执行气体，填料密封试验，高低温试验，冲击抗震试验，扭矩及疲劳试验等。

All pressure containing items are hydrostatically tested, seat leakage tested and functionally tested. We can also perform gas, packing emission, cryogenic and advanced functional testing.

## 可靠的使用业绩

### A proven track record

KELK 为许多工业用户提供阀门产品，有着大量可靠的使用业绩。

我们的阀门产品拥有行业内著名的品牌，每个品牌都因为优异的产品质量和可靠性而建立了良好的信誉。

KELK has extensive references and a proven track record in the supply of valves across a number of key industries.

Our valves are industry renowned brands, each with an established reputation for quality engineering and reliability.



疲劳试验装置  
Fatigue test device



扭矩测试台  
Torque test bench

## 材料测试

### Material testing

- 无损检测 X 射线、超声、磁粉和渗透。
- 化学分析由计算机控制的直读发射光谱仪。
- 机械试验在室温和高温下的拉伸性能、弯曲和硬度测试。夏比冲击试验在常温、高温和零下的温度。

- Non-destructive examination by radiography, ultrasonics, magnetic particle and liquid penetrant.
- Chemical analysis by computer controlled direct reading emission spectrometer.
- Mechanical testing for tensile properties at ambient and elevated temperatures, bend and hardness testing. Charpy testing at ambient, elevated and sub-zero temperatures.

## 售后市场解决方案 Aftermarket solutions

我们提供全面的维护服务，包括从零部件的供应以维修设备的单一部件，到多个产品和现场的各种形式的维护合同，旨在减少设备故障和计划外的维修。在适当的情况下，我们可以结合客户的操作，与客户树立共同的合作目标，以降低客户的经营风险和成本。

From the supply of parts to the repair of a single item of equipment we offer comprehensive maintenance across multiple products and sites by various forms of contract frameworks designed to reduce equipment failure and unplanned repairs. Where appropriate, we can integrate with our customers' operations, working to common goals to reduce operational risk and cost of ownership.



现场服务  
Site service

## 我们阀门售后服务包括： Our valve aftermarket services include

- 停机管理
- 调节阀解决方案
- 现场阀座替换
- 执行机构解决方案
- 在线安全阀测试和分析
- 诊断测试
- 备件支持
- 定制培训
- Outage and shutdown management
- Control valve service solutions
- In-situ valve seat replacement
- Actuation service solutions
- Online safety valve testing and analysis
- Diagnostic testing
- Spare parts support
- Customised training

**任何有效服务程序的核心是现场服务人员的技能和经验。**

**The core of any effective valve service program is the skill and experience of the technicians and supervisors who come to your site:**

- 大量的参考项目和可靠的工作业绩供参考
- 对细节和整个系统的理解能力
- 核心的可靠性维护
- 针对 KELK 技术人员的系统性培训及最新的安全标记
- Extensive references and proven track record
- Detailed and full system understanding
- Reliability-centred maintenance
- Up-to-date Systematic training and security badging for KELK valve technicians



综合管理  
Integrated management



生命周期  
Product life



现场维护  
Site maintenance

### SERIES GV110

- 小流量单座调节阀
- Small Flow Single Seated Valves

#### 阀门特性 Features

- 耐压高，最高可达 32MPa
- 阀芯形状可选择针型或 V 型口
- 针形阀芯更容易调节，调节灵敏度高；V 型口阀芯不容易折断
- 最小调节 CV 达到 0.001
- High pressure, up to 32MPa.
- Plug can be needle type or V type.
- Needle plug is more flexible and with high sensitivity.V type plug is strong even in case of really high pressure difference.
- High accuracy control, good control of micro flow low to CV 0.001.



#### 公称通径 Connection size

- 1/2"~1"(DN15~DN25)

#### 公称压力 Body rating

- ANSI 150#~600#

#### 连接方式 Connection style

- 法兰式 (Flanged) SW,BW etc.

#### 流量特性 Characteristic

- 等百分比或线性 Eq% or Linear
- 开关 ON-OFF

#### 泄漏等级 Seat leakage

- 金属硬密封 Metal seat class IV & V
- PTFE 软密封 Soft seat class VI

#### 阀门性能 Performance

- 调节精度高
- High adjustment accuracy
- 可流量试验验证
- Flow test verification

### SERIES GV120

- 顶部导向型单座调节阀
- Top Guided Single Seated Valves

#### 阀门特性 Features

- 适用于低压差，标准噪音，非空化场合
- 体积小、流道简单、低流阻、流通能力大
- 适用于含有悬浮物和颗粒状介质流体可避免结焦和堵塞，可控制高粘度流体
- 高精度，高性能调节功能
- Suitable for low DP, normal noise and non cavitation conditions.
- Small size, simple flow channel,low flow resistance and large CV.
- Suitable for fluids with suspended solids, good control of high viscosity fluids.
- High precision and adjustable performance.

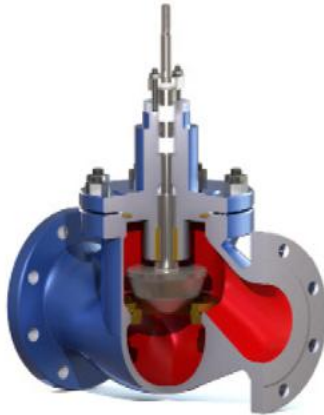

#### 公称通径 Connection size

- 1/2"~8"(DN15~DN200)

#### 公称压力 Body rating

- ANSI 150#~600#

#### 连接方式 Connection style

- 法兰式 (Flanged) SW,BW etc.

#### 流量特性 Characteristic

- 等百分比或线性 Eq% or Linear
- 开关 ON-OFF

#### 泄漏等级 Seat leakage

- 金属硬密封 Metal seat class IV & V
- PTFE 软密封 Soft seat class VI

#### 阀门性能 Performance

- 最简单实用的阀型
- The simplest and practical valve type
- 流向低进高出
- Flow direction low in high out

### SERIES GA110

- 顶部导向型单座角阀
- Top Guided Single Seated Control Valves

#### 阀门特性 Features

- 适用于低压差，标准噪音，非空化场合
- 体积小、流道简单、低流阻、流通能力大
- 适用于含有悬浮物和颗粒状介质流体可避免结焦和堵塞，可控制高粘度流体
- 高精度，高性能调节功能
- Suitable for low DP, normal noise and non cavitation conditions
- Small size, simple flow channel,low flow resistance and large CV
- Suitable for fluids with suspended solids, good control of high viscosity fluids
- High precision and adjustable performance



#### 公称通径 Connection size

- 1/2"~8"(DN15~DN200)

#### 公称压力 Body rating

- ANSI 150#~600#

#### 连接方式 Connection style

- 法兰式 (Flanged) SW,BW etc.

#### 流量特性 Characteristic

- 等百分比或线性 Eq% or Linear
- 开关 ON-OFF

#### 泄漏等级 Seat leakage

- 金属硬密封 Metal seat class IV & V
- PTFE 软密封 Soft seat class VI

#### 阀门性能 Performance

- 适用于锻件材料
- Available forging materials

### SERIES GV310/320

- 三通分（合）流调节阀
- 3-way Diverting (or Mixing) Valves

#### 阀门特性 Features

- 结构简单，阀芯和套筒不易卡阻
- 可以用于高温、高压的场合
- 主要用于三通合流或者分流调节场合，无法承受太高的关闭压差
- 非平衡型阀芯结构
- With simple structure and the blockage of plug and cage are reduced.
- It can be applied to high temperature and high pressure occasions.
- Mainly used for control of 3-way diverting or mixing occasions.
- Un-balanced plug structure.

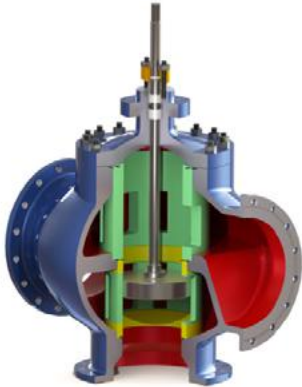

#### 公称通径 Connection size

- 1"~24"(DN25~DN600)

#### 公称压力 Body rating

- ANSI 150#~600#

#### 连接方式 Connection style

- 法兰式 (Flanged) SW,BW etc.

#### 流量特性 Characteristic

- 等百分比或线性 Eq% or Linear
- 开关 ON-OFF

#### 泄漏等级 Seat leakage

- 金属硬密封 Metal seat class IV & V
- PTFE 软密封 Soft seat class VI

#### 阀门性能 Performance

- 可设计成平衡型阀芯
- It can be designed as balanced type

### SERIES GV120H

- 高压顶部导向型单座调节阀
- High-Pressure Top Guided Single Seated Valves

#### 阀门特性 Features

- 适用于低压差，标准噪音，非空化场合
- 体积小、流道简单、低流阻、流通能力大
- 适用于含有悬浮物和颗粒状介质流体可避免结焦和堵塞，可控制高粘度流体
- 高精度，高性能调节功能
- Suitable for low DP, normal noise and non cavitation conditions.
- Small size, simple flow channel, low flow resistance and large CV.
- Suitable for fluids with suspended solids, good control of high viscosity fluids.
- High precision and adjustable performance.

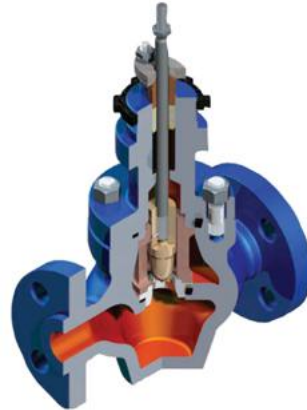

#### 公称通径 Connection size

- 3/4"~4"(DN20~DN100)

#### 公称压力 Body rating

- ANSI 900#~2500#

#### 连接方式 Connection style

- 法兰式 (Flanged) SW,BW etc.

#### 流量特性 Characteristic

- 等百分比或线性 Eq% or Linear
- 开关 ON-OFF

#### 泄漏等级 Seat leakage

- 金属硬密封 Metal seat class IV & V
- PTFE 软密封 Soft seat class VI

#### 阀门性能 Performance

- 套筒导向型
- Cage guided
- 阀芯阀杆一体式
- The plug and stem are integrated

### SERIES GA110H

- 高压顶部导向型单座角阀
- High-Pressure Top Guided Single Seated Valves

#### 阀门特性 Features

- 适用于低压差，标准噪音，非空化场合
- 体积小、流道简单、低流阻、流通能力大
- 适用于含有悬浮物和颗粒状介质流体可避免结焦和堵塞，可控制高粘度流体
- 高精度，高性能调节功能
- Suitable for low DP, normal noise and non cavitation conditions.
- Small size, simple flow channel, low flow resistance and large CV.
- Suitable for fluids with suspended solids, good control of high viscosity fluids.
- High precision and adjustable performance.

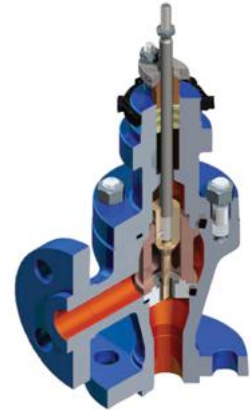

#### 公称通径 Connection size

- 1/2"~2"(DN15~DN50)

#### 公称压力 Body rating

- ANSI 900#~2500#

#### 连接方式 Connection style

- 法兰式 (Flanged) SW,BW etc.

#### 流量特性 Characteristic

- 等百分比或线性 Eq% or Linear
- 开关 ON-OFF

#### 泄漏等级 Seat leakage

- 金属硬密封 Metal seat class IV & V
- PTFE 软密封 Soft seat class VI

#### 阀门性能 Performance

- 套筒导向型
- Cage guided
- 阀芯阀杆一体式
- The plug and stem are integrated

### SERIES GC120/210

- 套筒导向型调节阀
- Cage Guided Single Seated Valves

#### 阀门特性 Features

- 平衡型阀芯，适用于较高的压差
- 可以用于高温、高压的场合
- 坚固的套筒保护阀体，使阀体不受阀蒸和空化的破坏
- 适用于各种严苛工况
- It is characterized by pressure balanced type trim for very high press drops.
- It can be applied to high temperature and high pressure occasions.
- With the solid cage, valve body is protected from steam and cavitation damage.
- It is suitable to a variety of heavy services.

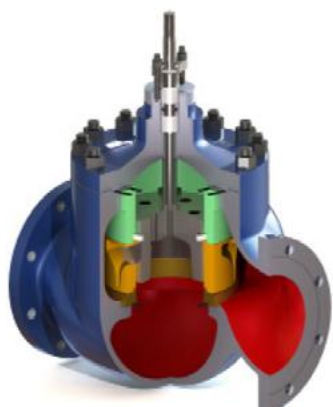

#### 公称通径 Connection size

- 1"~24"(DN25~DN600)

#### 公称压力 Body rating

- ANSI 150#~2500#

#### 连接方式 Connection style

- 法兰式 (Flanged) SW,BW etc.

#### 流量特性 Characteristic

- 等百分比或线性 Eq% or Linear
- 开关 ON-OFF

#### 泄漏等级 Seat leakage

- 金属硬密封 Metal seat class IV & V
- PTFE 软密封 Soft seat class VI

#### 阀门性能 Performance

- 套筒可根据工况更换
- The cage can be replaced
- 双向密封
- Two-way seal

### SERIES GC320

- 迷宫式套筒控速调节阀
- Labyrinth Cage Velocity Valves

#### 阀门特性 Features

- 采用多级降压套筒
- 有效防止液体产生气蚀现象
- 是一种无气蚀损伤，低噪音，控制流体稳定的调节阀
- 调节范围广
- With multi-stage cage ,which can effectively control the fluid speed.
- This valve can prevent fluid cavitation effectively as well as reducing noise.
- It is a valve with no cavitation damage,low noise and stable control fluid.
- Wide adjustment range

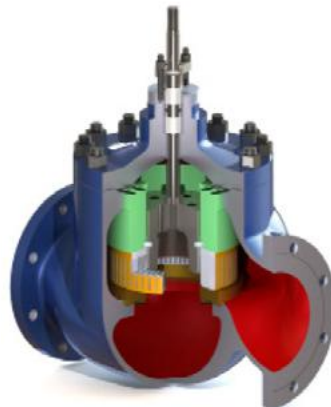

#### 公称通径 Connection size

- 1"~24"(DN25~DN600)

#### 公称压力 Body rating

- ANSI 150#~2500#

#### 连接方式 Connection style

- 法兰式 (Flanged) SW,BW etc.

#### 流量特性 Characteristic

- 等百分比或线性 Eq% or Linear
- 开关 ON-OFF

#### 泄漏等级 Seat leakage

- 金属硬密封 Metal seat class IV & V
- PTFE 软密封 Soft seat class VI

#### 阀门性能 Performance

- 最高能做到 128 级降压
- The stages can reach 128 levels
- 流量曲线可根据要求设计
- The flow curve can be specially designed

### SERIES GC410

- 多段式套筒控速调节阀
- Contoured Cage Velocity Valves

#### 阀门特性 Features

- 由套筒导向的低噪音、防气蚀调节阀
- 套筒采用多级式 (II 级或 III 级)
- 可根本消除高压差气体或蒸汽所产生的流体噪音，防止高压差流体产生空化破坏
- 适用于各种严苛工况
- It is a low-noise,cavitation resistant regulating valve guided by a cage.
- The cage is multi-stage ,which can control the fluid speed effectively.
- It can eliminate the fluid noise ,and also effectively prevent cavitation damage.
- It is suitable to a variety of heavy services.

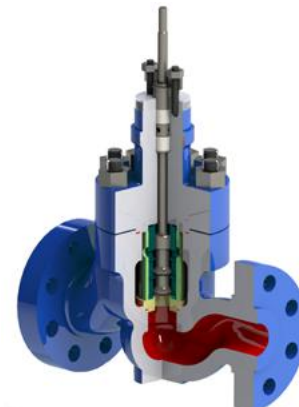

#### 公称通径 Connection size

- 1"~24"(DN25~DN600)

#### 公称压力 Body rating

- ANSI 150#~2500#

#### 连接方式 Connection style

- 法兰式 (Flanged) SW,BW etc.

#### 流量特性 Characteristic

- 等百分比或线性 Eq% or Linear
- 开关 ON-OFF

#### 泄漏等级 Seat leakage

- 金属硬密封 Metal seat class IV & V
- PTFE 软密封 Soft seat class VI

#### 阀门性能 Performance

- 适用于含杂质介质
- Applicable to media containing impurities



### SERIES GA120/210

- 套筒导向型调节角阀
- Cage Guided Single Seated Angle Valves

#### 阀门特性 Features

- 平衡型阀芯，适用于较高的压差
- 可以用于高温、高压的场合
- 坚固的套筒保护阀体，使阀体不受阀蒸和空化的破坏
- 适用于各种严苛工况
- It is characterized by pressure balanced type trim for very high press drops.
- It can be applied to high temperature and high pressure occasions.
- With the solid cage, valve body is protected from steam and cavitation damage.
- It is suitable to a variety of heavy services.

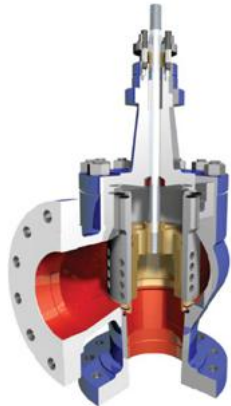

#### 公称通径 Connection size

- 1"~16"(DN25~DN400)

#### 公称压力 Body rating

- ANSI 150#~2500#

#### 连接方式 Connection style

- 法兰式 (Flanged) SW,BW etc.

#### 流量特性 Characteristic

- 等百分比或线性 Eq% or Linear
- 开关 ON-OFF

#### 泄漏等级 Seat leakage

- 金属硬密封 Metal seat class IV & V
- PTFE 软密封 Soft seat class VI

#### 阀门性能 Performance

- 套筒可根据工况更换
- The cage can be replaced
- 双向密封
- Two-way seal

### SERIES GA320

- 迷宫式套筒控速调节角阀
- Labyrinth Cage Velocity Angle Valves

#### 阀门特性 Features

- 采用多级降压套筒
- 有效防止液体产生气蚀现象
- 是一种无气蚀损伤，低噪音，控制流体稳定的调节阀
- 调节范围广
- With multi-stage cage ,which can effectively control the fluid speed.
- This valve can prevent fluid cavitation effectively as well as reducing noise.
- It is a valve with no cavitation damage,low noise and stable control fluid.
- Wide adjustment range

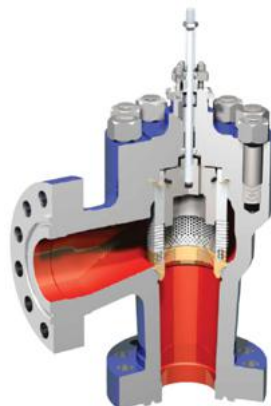

#### 公称通径 Connection size

- 1"~16"(DN25~DN400)

#### 公称压力 Body rating

- ANSI 150#~2500#

#### 连接方式 Connection style

- 法兰式 (Flanged) SW,BW etc.

#### 流量特性 Characteristic

- 等百分比或线性 Eq% or Linear
- 开关 ON-OFF

#### 泄漏等级 Seat leakage

- 金属硬密封 Metal seat class IV & V
- PTFE 软密封 Soft seat class VI

#### 阀门性能 Performance

- 最高能做到 128 级降压
- The stages can reach 128 levels
- 流量曲线可根据要求设计
- The flow curve can be specially designed

### SERIES GA410

- 多段式套筒控速调节角阀
- Contoured Cage Velocity Angle Valves

#### 阀门特性 Features

- 由套筒导向的低噪音、防气蚀调节阀
- 套筒采用多级式 (II 级或 III 级)
- 可根本消除高压差气体或蒸汽所产生的流体噪音，防止高压差流体产生空化破坏
- 适用于各种严苛工况
- It is a low-noise,cavitation resistant regulating valve guided by a cage.
- The cage is multi-stage ,which can control the fluid speed effectively.
- It can eliminate the fluid noise ,and also effectively prevent cavitation damage.
- It is suitable to a variety of heavy services.



#### 公称通径 Connection size

- 1"~16"(DN25~DN400)

#### 公称压力 Body rating

- ANSI 150#~2500#

#### 连接方式 Connection style

- 法兰式 (Flanged) SW,BW etc.

#### 流量特性 Characteristic

- 等百分比或线性 Eq% or Linear
- 开关 ON-OFF

#### 泄漏等级 Seat leakage

- 金属硬密封 Metal seat class IV & V
- PTFE 软密封 Soft seat class VI

#### 阀门性能 Performance

- 适用于含杂质介质
- Applicable to media containing impurities

### SERIES GA510/520

- 低温铝角阀
- Cryogenic Aluminum Angle Valves

#### 阀门特性 Features

- 是一种在深冷场合使用的调节阀
- 采用长颈阀盖；配保温硅胶套
- 阀体采用精密锻造角型结构；具有结构紧凑，重量轻，稳定性好等优点
- 可设计成抽芯式
- Cryogenic Aluminum Angle is a control valve used in cryogenic applications.
- It is with long bonnet and insulation silicone case.
- Precision forging angle structure are used for valvebody with advantage of light weight.
- It can be designed as core-pulling type.

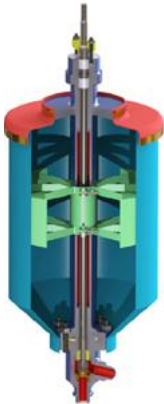

#### 公称通径 Connection size

- 3/4"~8"(DN20~DN200)

#### 公称压力 Body rating

- PN1.6~PN6.3MPa

#### 连接方式 Connection style

- 焊接式 BW

#### 流量特性 Characteristic

- 等百分比或线性 Eq% or Linear
- 开关 ON-OFF

#### 泄漏等级 Seat leakage

- 金属硬密封 Metal seat class IV & V
- PTFE 软密封 Soft seat class VI

#### 阀门性能 Performance

- 阀体材质：铝合金 5083/LF4
- Body material:aluminium alloy
- 上阀盖材质 :CF8
- Bonnet material:CF8

阀门材料可接受各种铸钢、锻钢或合金材料，可设计成低温、夹套、波纹管 and 散热片型。  
Valve material is available in most materials and can be designed as cryogenic, jacket, bellows and fin-extension type.

### SERIES GZ800

- 自力式调节阀
- Self-operated Pressure Valves

#### 阀门特性 Features

- 是一种弹簧设定直接作用通用性调节阀
- 依靠介质自身的压力变化达到调节目的
- 广泛应用于蒸汽、各类低腐蚀气体及低粘度液体的压力调节
- 密封可靠，阀杆为长波纹管结构
- Self-operated Pressure Control Valves is a direct effect of the spring set universal valve.
- It is directly regulated by the pressure change of the medium itself.
- It is used in corrosive gases and various types of low viscosity low adjustment.
- It has a long bellow structure.



#### 公称通径 Connection size

- 1/2"~10"(DN15~DN250)

#### 公称压力 Body rating

- ANSI 150#~2500#

#### 连接方式 Connection style

- 法兰式 (Flanged) SW,BW etc.

#### 流量特性 Characteristic

- 等百分比或线性 Eq% or Linear
- 开关 ON-OFF

#### 泄漏等级 Seat leakage

- 金属硬密封 Metal seat class IV & V
- PTFE 软密封 Soft seat class VI

#### 阀门性能 Performance

- 可设计成微压调节
- It can be adjusted by micro-pressure
- 弹簧可内置
- Spring can be built in

### SERIES GT120

- 平行闸阀
- Parallel Gate Valves

#### 阀门特性 Features

- 采用金属接触式结构
- 动作可靠具有极高的切断性能
- 广泛应用于高温高压到极低温工况的紧急切断、放空以及调节
- 适用于各种工况
- It uses a high-performance parallel gate metal contact structure.
- The parallel gate valve operates reliably and has extremely high cutting performance.
- It used in high temperature, pressure to emergency shut-off, venting and adjustment.
- It is suitable to a variety of services.

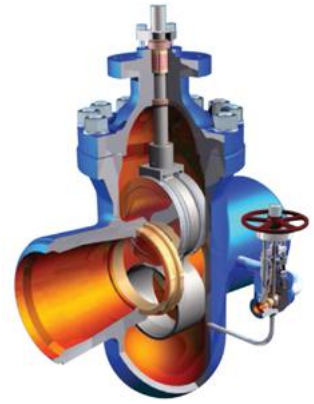

#### 公称通径 Connection size

- 1-1/2"~54"(DN40~DN1350)

#### 公称压力 Body rating

- ANSI 150#~2500#

#### 连接方式 Connection style

- 法兰式 (Flanged) SW,BW etc.

#### 流量特性 Characteristic

- 等百分比或线性 Eq% or Linear
- 开关 ON-OFF

#### 泄漏等级 Seat leakage

- 金属硬密封 Metal seat class IV & V
- PTFE 软密封 Soft seat class VI

#### 阀门性能 Performance

- 高压带碟形弹簧
- High pressure type with bellville spring
- 压力自密封
- Pressure self-sealing

### SERIES BC110

- V 型调节球阀
- V-port Ball Control Valves

#### 阀门特性 Features

- V 形切口增大可调比，可调比高达 500:1
- V 形切口在截流时对密封环具有剪切作用
- 对含纤维质流体、料浆类流体的控制具有特别良好的效果
- 阀座带有增能环
- The V-shaped notch of the valve increases the adjust ratio up to 500:1.
- This V shape provide a function of shearing to the sealing ring.
- It has a good performance of controlling fibrous flow and slurry fluid.
- With a energy enhancement ring.



#### 公称通径 Connection size

- 1"~16"(DN25~DN400)

#### 公称压力 Body rating

- ANSI 150#~1500#

#### 连接方式 Connection style

- 法兰式 (Flanged) 对夹式 (WF)

#### 流量特性 Characteristic

- 近似等百分比 App Eq%
- 开关 ON-OFF

#### 泄漏等级 Seat leakage

- 金属硬密封 Metal seat class IV & V
- PTFE 软密封 Soft seat class VI

#### 阀门性能 Performance

- 可选防卡结构
- The slurry type is optional
- 可选放空化结构
- The anti cavitation type is optional

### SERIES BE110

- 偏心调节球阀
- Eccentric Ball Control valves

#### 阀门特性 Features

- 流路简单，Cv 值大，自洁性能好
- 适用于结晶、结巴及不干净介质场合
- 广全开时流通能力大，压力损失小，且介质不会沉积在阀体中腔
- 体积小，重量轻
- With simple flow path, large Cv value and good self-cleaning performance.
- It is suitable for occasions with un-clean flow media and crystallization.
- It small pressure loss and no medium deposit in the valve body cavity.
- Small size and light weight.

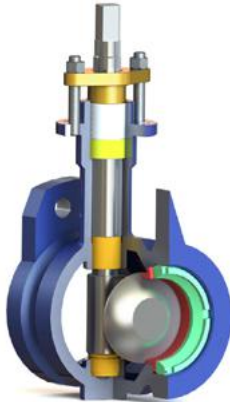

#### 公称通径 Connection size

- 1"~12"(DN25~DN300)

#### 公称压力 Body rating

- ANSI 150#~1500#

#### 连接方式 Connection style

- 法兰式 (Flanged) 对夹式 (WF)

#### 流量特性 Characteristic

- 近似等百分比 App Eq%
- 开关 ON-OFF

#### 泄漏等级 Seat leakage

- 金属硬密封 Metal seat class IV & V
- PTFE 软密封 Soft seat class VI

#### 阀门性能 Performance

- 可选防卡结构
- The slurry type is optional
- 可选放空化结构
- The anti cavitation type is optional

### SERIES BV130

- 高性能软密封直通球阀
- High Performance Ball Valves

#### 阀门特性 Features

- 具有极优的切断性能
- 适用于液体、气体、浆料等的切断控制
- 防火设计。PTFE 的阀座烧毁或汽化时，由阀体上加工成的金属阀座起密封作用
- 防静电设计
- With excellent cutting performance, the flow channel is the same to the pipe diameter.
- Applicable to cut-off control of liquid, gas, slurry, etc.
- Special design of metal seat could replace PTFE seat, which might be melted or gasified.
- Anti-static design.

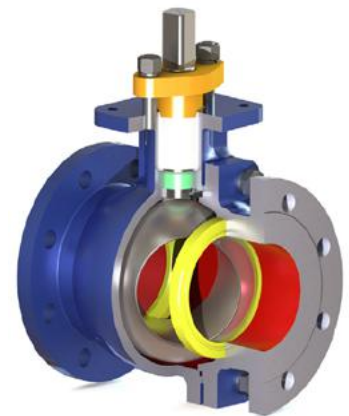

#### 公称通径 Connection size

- 1/2"~24"(DN15~DN600)

#### 公称压力 Body rating

- ANSI 150#~2500#

#### 连接方式 Connection style

- 法兰式 (Flanged)

#### 流量特性 Characteristic

- 开关 ON-OFF

#### 泄漏等级 Seat leakage

- PTFE 软密封 Soft seat class VI

#### 阀门性能 Performance

- 可承受 250℃ 高温
- Withstand 250℃ high temperature

### SERIES BV210

- 金属硬密封球阀
- Metal-seated Ball Valves

#### 阀门特性 Features

- 球阀阀座表面喷焊镍基合金
- 较高的硬度，适用在有颗粒粉尘的场合
- 耐磨性能良好，密封性能良好，开关轻，使用寿命长
- 最高耐温可达 538℃
- Spray welding nickel base alloy to the valve ball and valve seat surface.
- It has a good performance of controlling fibrous flow and slurry fluid.
- Good wear resistance, sealing performance, and light switch, long service life.
- Maximum temperature resistance 538℃ .

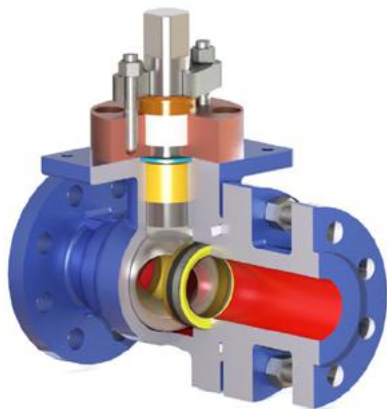

#### 公称通径 Connection size

- 1/2"~24"(DN15~DN600)

#### 公称压力 Body rating

- ANSI 150#~2500#

#### 连接方式 Connection style

- 法兰式 (Flanged) SW,BW etc.

#### 流量特性 Characteristic

- 开关 ON-OFF

#### 泄漏等级 Seat leakage

- 金属硬密封 Metal seat class V & VI

#### 阀门性能 Performance

- 阀杆防吹出设计
- Internally blowout proof stem
- 低泄漏认证
- Low leakage certification

### SERIES BT110

- 低负载轻型蝶阀
- Light Load Butterfly Valves

#### 阀门特性 Features

- 采用钢板焊接结构
- 分为开放型、15° 密封型和后座型
- 构造简单，结构轻巧，适用于低压状态的空气或其它气体的流量、压力控制
- 适用于高温状态气体
- Light load butterfly valves of steel plate welding structure.
- There are three types: open type, 15° sealed type and rear seat type.
- Suitable for flow and pressure control of low pressure air or other gas.
- Suitable for high temperature gas.



#### 公称通径 Connection size

- 3"~128"(DN80~DN3200)

#### 公称压力 Body rating

- PN0.25~PN1.6MPa

#### 连接方式 Connection style

- 法兰式 (Flanged)

#### 流量特性 Characteristic

- 近似等百分比 App Eq%
- 开关 ON-OFF

#### 泄漏等级 Seat leakage

- 额定 (Rated)Cv×5%~0.2%

#### 阀门性能 Performance

- 可设计成多叶阀
- It can be designed as multi-leaf valve
- 可设计成组合风阀
- It can be designed as combined air valve

### SERIES BT210

- 高性能双偏心蝶阀
- Double Offset Butterfly Valves

#### 阀门特性 Features

- 阀门具有双向密封
- 防火设计
- 阀门密封性能好，密封环使用寿命长，维修量小
- 介质压力自密封
- The double offset butterfly valve has the characteristics of two way sealing.
- The valve has fireproof soft seal and metal seal seat.
- The valve has good sealing performance, long service life and small maintenance.
- Self-sealing of medium pressure.



#### 公称通径 Connection size

- 3"~60"(DN80~DN1500)

#### 公称压力 Body rating

- ANSI 150#~300#

#### 连接方式 Connection style

- 对夹式 (Wafer)

#### 流量特性 Characteristic

- 近似等百分比 App Eq%
- 开关 ON-OFF

#### 泄漏等级 Seat leakage

- PTFE 软密封 Soft seat class VI
- 金属硬密封 Metal seat Cv×0.01%~0.0001%

#### 阀门性能 Performance

- 可设计成外部轴承型
- It can be designed as outer bearing type
- 寿命高达 50 万次
- It can operate 50000 times

### SERIES BT310

- 三偏心蝶阀
- Triple Offset Butterfly Valves

#### 阀门特性 Features

- 密封圈选用多层次或全金属环
- 具有金属硬密封和弹性密封的双重优点
- 无论在低温和高温的情况下，均具有优良的密封性能
- 耐腐蚀，使用寿命长
- The valve sealing ring material is multi-layer or all-metal.
- Contributes dual advantages of metal sealing and thee lastic sealing.
- Always with excellent sealing performance no matter in low or high temperature.
- Corrosion resistant, long life.

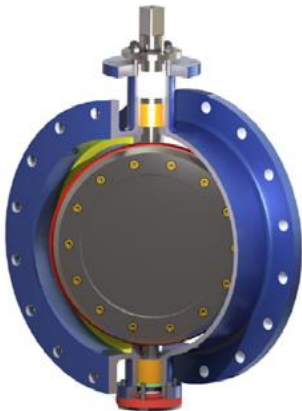

#### 公称通径 Connection size

- 3"~120"(DN80~DN3000)

#### 公称压力 Body rating

- ANSI 150#~600#

#### 连接方式 Connection style

- 法兰式 (Flanged)

#### 流量特性 Characteristic

- 近似等百分比 App Eq%
- 开关 ON-OFF

#### 泄漏等级 Seat leakage

- 金属硬密封 Metal seat class VI

#### 阀门性能 Performance

- 寿命高达 200 万次
- It can operate 2 million times
- 密封环互换性高
- High interchangeability of sealing ring

### SERIES BT510

- 三杆阀
- Three Lever Valves

#### 阀门特性 Features

- 利用四连杆机构原理实现阀板的开关
- 无摩擦脱离或贴合阀座密封，无挤压摩擦
- 阀前后压差大于 15 Kpa 时无法打开，有效防止分子筛冲床现象发生
- 使用寿命长
- It uses principle of four-lever linkage to open and close the valve plate.
- No friction for separation or fitting at seat sealing, neither extrusion friction.
- It will not open when inlet and outlet pressure difference is greater than 15 Kpa.
- Long service life.

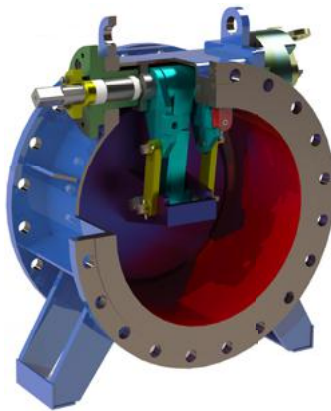

#### 公称通径 Connection size

- 12"~72"(DN300~DN1800)

#### 公称压力 Body rating

- PN0.25~PN4.0MPa

#### 连接方式 Connection style

- 法兰式 (Flanged)

#### 流量特性 Characteristic

- 开关 ON-OFF

#### 泄漏等级 Seat leakage

- 金属硬密封 Metal seat class VI

### SERIES PC1240

- 气动马达
- Pneumatic motor

#### 阀门特性 Features

- 金属外壳，结构牢固，寿命长
- 启动扭矩大，力矩平衡，运转匀速平稳
- 气动马达本质安全，可在不停工状态下加以改造
- 可在 0~100% 之间任意调节开度
- With metal shell, solid structure and long service life.
- With large starting torque, balanced torque and stable operation.
- Intrinsically safe, can be modified without shutdown.
- Opening is adjustable between 0~100%.

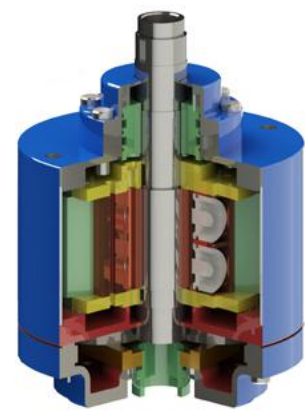

#### 输入信号 Input signal

- 4~6bar

#### 输出特性 Characteristic

- 固有特性 Inherent characteristic

#### 供气压力 Air supply

- 0.3Mpa~0.6Mpa

#### 损耗气量 Air consumption

- 0.6L/r~3.1L/r

#### 防护等级 Enclosure

- IP66

#### 使用温度 Environment Temp

- 标准型 (Standard):-30~280℃

## 压缩机防喘振阀

Turbo Compressor Anti-surge Valve

公称通径 Size

- 20"(DN500)

公称压力 Body rating

- ANSI 600#

阀门材质 Valve material

- A352-LCB

阀门性能 Performance

- 0.5 秒快速打开

- Open in 0.5s



## 阀内件的选择 Trim Options

### 恶劣工况专用迷宫式阀芯 Severe Service Trims

普通套筒阀分为线性套筒和等百分比套筒，根据不同的开口形状起到调节流量的作用。当流量增加或是压差提高的时候，阀门出口流速或阀内件流速都会提高，这个时候需要使用多孔式套筒阀来降低流速，相当于降噪板的小郭。当流速超过一定极限时，需要使用迷宫式套筒，通过多级降压的芯片，将压力逐级平缓递减，避免压力降低到饱和蒸汽压以下而形成空化。这几个套筒的外形尺寸一致，可以使用同一个阀座和阀体，根据不同的工况，套筒可以互换。一般情况下，我们会认为超过 20 BAR 的工况为恶劣工况，可以使用迷宫阀。

The normal cage guided valve can be designed to regulate flows with linear and equal percentage characteristics based on different opening shapes on the cages. The flow velocity at valve outlet and valve trim will increase when the flow rate or differential pressure increases. In this case, valves with multi-hole cage shall be applied to reduce the flow velocity, which is equivalent to the effect of a noise reduction plate. But when the flow velocity is up to a certain limit, a labyrinth cage is required to reduce the pressure step by step through a multi-stage cage to avoid cavitation caused by the sudden pressure drop. The external dimensions of these cages are consistent, so the same valve seat and valve body can be applied for different cage design. And the cages can be interchangeable according to different working conditions. In general, we would recommend labyrinth cage valve at the severe working condition with pressure drop over 20 Bar.

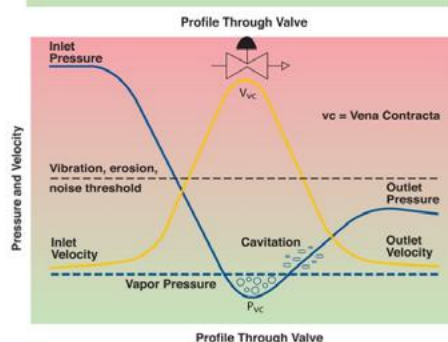
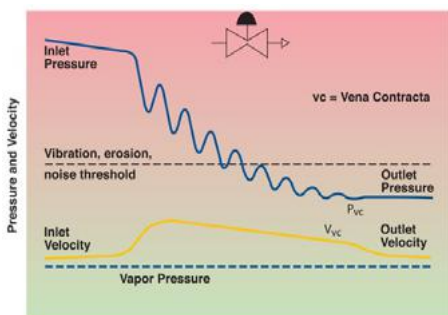
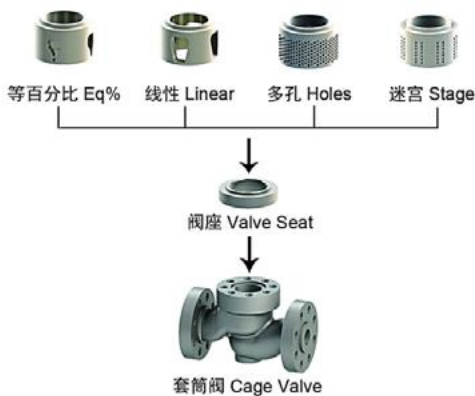

这是一种恶劣工况的解决方案，适用于各行业。无论是高压差，高气蚀指数，高压差闪蒸工况，高压差气体流体，我们都能从容面对，这种阀芯经过验证，其性能特点是使用寿命长，控制精度高，消除气蚀，抗冲刷能力强，解决了震动和噪音超标问题。

These trims extend the capability of KELK to offer trim designs for the most severe operating conditions now found in the various industries we serve. KELK is in the enviable position of being able to supply the most appropriate design for the specified application whether high pressure drop cavitating, highpressure drop flashing or high pressure drop gas applications. This proven trim design delivers accurate control, and long life, free from cavitation, erosion, vibration and noise problems.

迷宫阀芯满足大多数恶劣工况下用户提出的耐用性好，控制重复特性高，控制精度高，可靠性高的要求。这种先进的流速控制技术成功的消除了噪音和气蚀产生的源头。

The design has evolved through many decades of experience in solving severe service applications where durability, reliability, repeatability and control precision are required. The advanced design velocity control trim prevents generation of noise and/or cavitation at the source.

典型应用是压缩机的在循环控制和汽机旁路控制。迷宫式阀芯通过将流体通道分解成很多小通道，并使小通道发生多此折弯，极大地增加了流体阻力，从而有效地限制了流速，并将很高的入口压力逐步将压到出口压力。这也是多级糖葫芦串式阀芯的设计基本原理，但迷宫式阀芯使得每一级的压降更小，流速更低，控制更细腻，因而适合于大多数可用阀芯材料。

The typical applications for which the trim has been applied also include compressor recycle and turbine by-pass. This trim limits harmful flow velocities by separating the flow into smaller individual channels, and staging the full pressure drop across multiple turns in the fluid path.

对于天然气 / 蒸汽应用调节阀的选型，主要考虑气动噪音、振动、高流速等重要因素。这些因素都是互相关联的，高流速会导致机械振动，机械振动又会致机械噪音，高流速还会导致气动噪音。所以除了必须控制阀芯各级之间的流速外，还要控制阀门出口流速以及下游管道内的流速。管道布置不合理如前后弯头过近，也会严重影响阀门运行。

The major factors to be considered in the selection of a valve trim on a gas/vapour service are aerodynamic noise generation, vibration, and high fluid velocities. Each of these are interrelated in that high velocities can lead to vibration and resultant noise, and will also generate aerodynamic noise.

迷宫阀的多级降压的气体工作原理与液体工况非常相似，也是将气体 / 蒸汽通过径向的开孔分流成很多小股流体，对于气体应用首选低进高出流向，这样沿流向上流通面积逐级增加，与上进下出相比，出口流速更低，气动噪音大幅衰减。

The trims work in a similar principle to the liquid service designs, in that they split the flow up into a large number of radial jets, see Figure 9. The preferred flow direction is 'under' the plug, this enables the optimum flow area increase as the flow passes through each stage of the trim.

这种几何结构使流体被径向小孔分解成一系列小股喷射流体，在流入下一套筒之前发生流向转折，并互相碰撞，消耗动能，这就很好地控制了噪音的形成。对于大多数恶劣工况，上面讨论描述过的迷宫阀都具有非常好的噪音衰减控制能力。

The flow geometry means that the process fluid enters the cage radially and passes through the subsequent sleeves in a tortuous path resulting in high frictional and impingement losses.

# 消音器的应用

## Silencers Application

在解决气动噪音问题方面，必须认识到调节阀下游的流速也必须得到很好的控制，否则会在下游管道内产生二次噪音，而且这种噪音水平显著高于阀芯内部。通用解决办法是将下游流速严格地限制在0.3倍音速以内。可压缩性气体的流速出现显著变化也是在0.3倍的音速。为了解决这个问题，在阀门下游加装一个消音器，实际上就是在口径逐级增大的管道内设置一系列阻流挡板（在圆盘上开有一些小孔），以此提高阀门的出口背压，使阀芯出口到下游管道内的流速低于0.3马赫。在选择阻流挡板的级数以及各级挡板的流通Cv值时，必须结合阀芯的Cv值，确保在全部可能的工况下都能有效控制流速。这种成功的解决办法已经被我们应用了30多年。如今已经有大量的这种装置安装在石油、天然气以及电站行业。

In solving the aerodynamic noise generation problem it must also be recognised that there is a need to control downstream velocities, otherwise high pipeline velocities can produce secondary noise which could be significantly higher than that produced by the valve trim. It is generally accepted that to achieve a low-noise solution, the downstream velocity should be restricted to less than 0.3 times the fluid sonic velocity. This coincides with the velocity at which compressibility effects start to become noticeable. In order to address this problem, We utilises downstream silencers in the form of a taper pipe fitted with a number of baffle plates (circular plates with a number of drilled holes). These are used to produce a back-pressure to the valve and are selected so that the velocity from the trim exit to the valve outlet is less than 0.3 times sonic velocity (0.3 Mach). In selecting these devices it is necessary to ensure that the trim and silencer system operate effectively over the full range of operating conditions. This approach has effectively been used by US for more than 30 years. A large number of these units are installed in the oil and gas and power sectors.

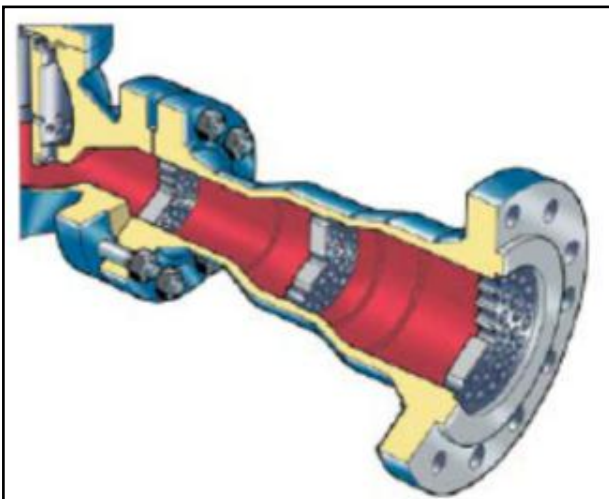



## 阀盖形式 Bonnet Forms

### 标准型

适用于流体温度介于  $-17^{\circ}\text{C}$  和  $23^{\circ}\text{C}$  之间的应用场合。也可与石墨填料一起使用，温度可高达  $315^{\circ}\text{C}$ 。虽然有填料可以适用于更高的温度场合，但考虑到阀体温度的影响，如果超过上述温度值，建议还是使用散热片阀盖。

### Standard

For applications where the temperature of the controlled fluid is between  $-17^{\circ}\text{C}$  and  $232^{\circ}\text{C}$ . May be used with graphite packing up to  $315^{\circ}\text{C}$ . Although modern packagings are suitable for much higher temperatures, it is recommended that the normalising bonnet be fitted in cases where the temperatures exceed the above values to accommodate lagging of the control valve body.

### 散热片型

在高于  $232^{\circ}\text{C}$  和低于  $-45^{\circ}\text{C}$  至  $-75^{\circ}\text{C}$  温度下，阀盖可设计为散热片型，以帮助流体介质散热，保护填料和执行器组件免受高温影响。相比标准型阀盖，散热片型阀盖更长，方便隔断阀门流体温度，减少对执行器的影响。

### Normalising

For protection of the gland packing at temperatures above  $232^{\circ}\text{C}$  and below  $-45^{\circ}\text{C}$  down to  $-75^{\circ}\text{C}$ . The bonnet is designed with fins which dissipate the heat from process fluid and help protect the packings and actuator assembly from high temperatures. In addition, the normalising bonnet is longer than the standard bonnet so that the valve can easily be lagged without interference with the actuator.

### 蒸汽夹套

应用于对介质保温的场合，该型号阀门阀体为双层结构，其间带有某种温度介质（例如水蒸气），以维系阀门内介质的温度。经常使用于中国北部或俄罗斯等寒冷的地带。

### Steam jacket

used for medium insulation, this model valve body is a double-layer structure, with a certain temperature medium (such as water vapor), to maintain the temperature of the medium in the valve. Often used in cold regions such as northern China or Russia.

### 低温型

用于低于  $-100^{\circ}\text{C}$  的温度。阀盖设计有长颈段，可以将填料与流体介质隔开。长颈段设计有小型壁截面，可最大限度地减少温度传输。冷箱加长 / 低温阀盖也可供选择。

### Cryogenic

Used for temperatures below  $-100^{\circ}\text{C}$  ( $-150^{\circ}\text{F}$ ). The bonnet designed with a long necked section which distances the packing away from the process fluid. The necked section is designed with a minimum wall section to minimise heat transfer. Cold box extension/cryogenic bonnets are also available.

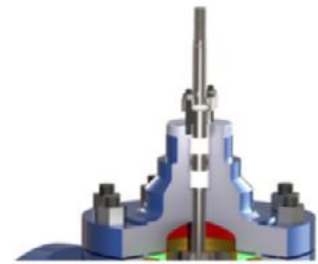

标准型



散热片型



蒸汽夹套型



加长型

## 波纹管密封型 Bellows Seal

在不允许任何泄漏的情况下，需采用波纹管防泄漏密封。标准波纹管材料为 321 不锈钢，但也可根据要求提供其他材料选择。波纹管密封设计中包含焊接型柔性钢波纹管，该波纹管夹在加长阀盖罩中，有效地切断了阀杆周围的泄漏路径，从而防止了阀门填料处的泄漏。在这种情况下，填料也可以看作是波纹管的后备增补。

A positive leakproof stem seal for cases where gland leakage cannot be permitted. The standard bellows material is 321 stainless steel, although many other materials are available on request. The design consists of a welded flexible steel bellows which is clamped in an extended bonnet/ bonnet hood. This effectively cuts out any possible leakage path around the plug stem and therefore prevents emissions from the valve packings. Packings are fitted in these valves but only act as a backup to the bellows.

常见的两个问题是填料区部位的泄漏以及阀杆摩擦的增加。这是由于固化盐渗透入填料函、填料降解和高热循环造成的损坏而引起的。随着泄漏的增加，越来越多的熔盐在填料区域凝固，于是上述问题更加严重。因此，禁止熔盐进入填料函这一点很重要。解决填料降解问题的办法可以使用昂贵的填料，但是其它两个问题无法解决。

Two common problems are leakage through the packing area and increased friction of the stem. This is caused due to abrasive damage from solidified salts (pulled into the packing box), packing degradation and high thermal cycling. As leakage increases, more and more Molten Salt solidifies in the packing area therefore increasing the above problems. It is important that Molten Salt is not allowed into the packing box area. Part of the solution to the degradation problem would be expensive packing materials, but this would not solve the other issues.

为避免使用昂贵的阀杆填料并确保对腐蚀性或“热”流体的最大密封性，传统方法是安装带石墨填料的波纹管加长型阀盖。在加长型阀盖内采用了两种密封技术，第一是波纹管特征，第二是离阀体位置最远的后备石墨填料（见图 06 和 07）。

The traditional method to avoid expensive stem packing and ensure maximum sealing on corrosive or “hot” fluids is by installing a bellows extended bonnet with graphite packing. This design incorporates two sealing technologies within the extended bonnet. The first is the bellows feature and the second is the back-up graphite packing which is farthest from the valve body.



波纹管型

加长型阀盖的目的是保持填料温度尽可能低，以便使用标准填料设计。此外，使用加长型阀盖也是为了方便安装波纹管装置。

The purpose of the extended bonnet is to keep the packing temperature as low as possible therefore allowing the use of standard packing designs. Additionally the extended bonnet is required to allow for the installation of the bellows unit.

波纹管装置焊接在阀杆底部，然后向上延伸并焊接到密封圈位置。然后将密封圈密封在加长型阀盖和上阀盖法兰之间。波纹管将熔盐与阀杆和阀杆填料区域隔离，从而确保熔盐留在阀体内部，并消除上述“常见”问题。

The bellows unit is welded to the bottom of the valve stem and then extends up and welded to a sealing ring. The sealing ring is then sealed between the extended bonnet and the upper bonnet flange. The bellows isolates the Molten Salt from both the stem and the stem packing area therefore ensuring it stays inside of the valve body, eliminating the above mentioned “common” problems.

以下图示为波纹管焊接在阀杆底部并向上传伸至密封圈  
Bellows welded to the bottom of the stem and at the top to a sealing ring

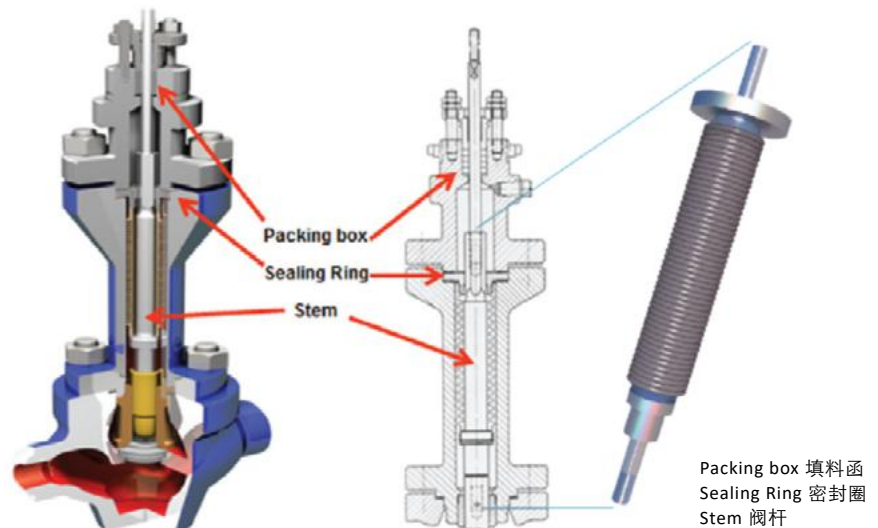

## 流量特性 Characteristics

### 线性

该流量特性中流量与阀门开度成正比，比例关系形成恒定斜率。在恒定压降的情况下，阀门增益在所有流量点都是相同的。线性阀门的阀芯通常设定用于需要恒定增益的液位控制和流量控制应用场合。

### Linear

This characteristic provides a flow rate which is directly proportional to the valve lift. The proportional relationship produces a characteristic with a constant slope, so that with constant pressure drop the valve gain will be the same at all flows. The linear valve plug is commonly specified for liquid level control and for flow control applications requiring constant gain.

### 等百分比

阀门开度的相等增量会使流体流量产生相等的百分比变化。流量变化始终与阀芯位置变化前的流量成比例。等百分比特性通常用于压力控制的应用场合，以及系统本身会消化较大百分比压降的应用场合。当压降变化较大或要求大可调比时，也可考虑此特性阀门。

### Equal Percentage

Equal increments of valve lift produce equal percentage changes in the fluid flow. The change in flow rate is always proportional to the flow rate just before the change in plug position is made. The equal percentage characteristic is generally used on pressure control applications, and on other applications where a large percentage of pressure drop is normally absorbed by the system itself. Valves with this characteristic should also be considered where highly varying pressure drop conditions occur or high rangeability is required.

### 快开

在阀门开度小的时候流量变化最大，具有一定的线性关系。阀门开度的进一步增加，流量变化会急剧减少。当阀芯接近全开位置时，流量变化接近于零。

### Quick Opening

This provides for maximum change in flow rate at low valve lifts with a fairly linear relationship. Additional increases in valve lift give sharply reduced changes in flow rate. When the valve plug nears the wide open position, the change in flow rate approaches zero.

### 中间

可根据客户要求提供中间性或其他特殊特性，也可满足非连续平滑的曲线，如大可调比等，以满足特定的控制要求。

### Intermediate

Other intermediate or special characteristics are available on request to meet specific control requirements.

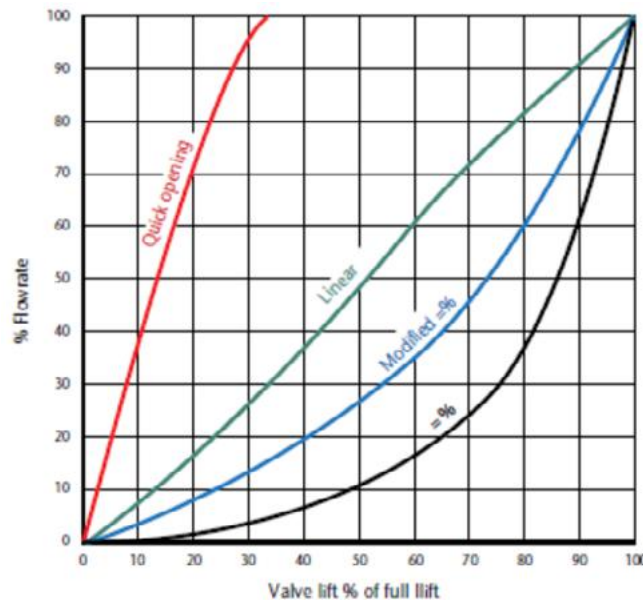

WUXI KELK APPARATUS & VALVE CO., LTD

Add: NO.6 DeYu Road,Hongshan

Town,Wuxi,Jiangsu,China

Tel: + 86-510-85141699

Fax: +86-510-85141819

Web: www.kelkflow.com.cn

E-mail: info@kelkflow.com.cn



**KELK**

我们的服务网络覆盖全球。中国区的服务划分以整个分公司区划为基础，在数量上合理控制，在能力上充分健全，分别有东北、华北、西北、新疆、西南、中南、华南、华东等八大中心，以及如吉林、海南、上海、兰州、福州、喀什等一些分支点。

Our service network covers the whole world. China's services division to the branch division as the foundation, in the number of reasonable control, in terms of quality, full sound, respectively, Northeast, North, Northwest, Xinjiang, Southwest, Central China, South China, East China, as eight centers etc, and such as Jilin, Hainan, Shanghai, Lanzhou, Fuzhou, Kashi some branching points.